

Bearing No. FWF-707620

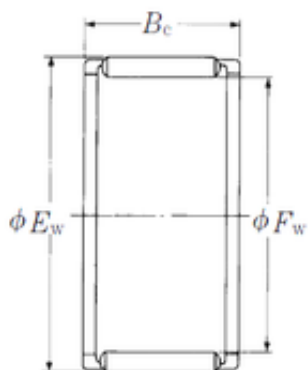

Fw	70 mm
Ew	76 mm
Bc	20 mm
Weight	0,062 Kg
Bearing number	FWF-707620
Bore Diameter (mm)	70
Outer Diameter (mm)	76
Basic dynamic load rating (C)	35,5 kN
Basic static load rating (C0)	82,5 kN