

Bearing No. FWF-707630

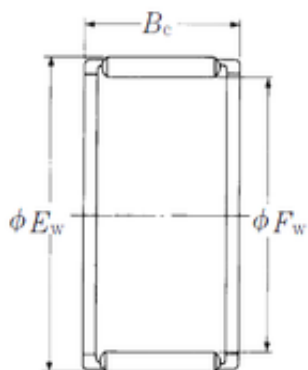

Fw	70 mm
Ew	76 mm
Bc	30 mm
Weight	0,093 Kg
Bearing number	FWF-707630
Bore Diameter (mm)	70
Outer Diameter (mm)	76
Basic dynamic load rating (C)	53,5 kN
Basic static load rating (C0)	141 kN