

Bearing No. FWF-808620

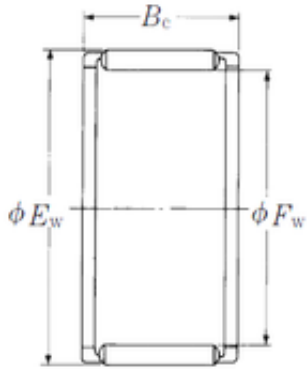

Fw	80 mm
Ew	86 mm
Bc	20 mm
Weight	0,071 Kg
Bearing number	FWF-808620
Bore Diameter (mm)	80
Outer Diameter (mm)	86
Basic dynamic load rating (C)	38 kN
Basic static load rating (C0)	94 kN