

Bearing No. FWF-859325

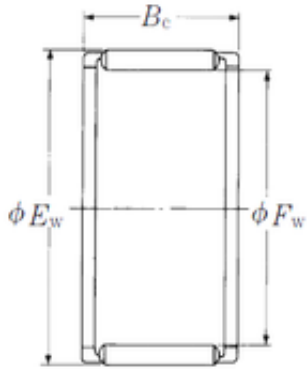

Fw	85 mm
Ew	93 mm
Bc	25 mm
Weight	0,125 Kg
Bearing number	FWF-859325
Bore Diameter (mm)	85
Outer Diameter (mm)	93
Basic dynamic load rating (C)	59 kN
Basic static load rating (C0)	139 kN